

# BAV70TT1G

## Dual Switching Diode

### Features

- These Devices are Pb-Free, Halogen Free/BFR Free and are RoHS Compliant

### MAXIMUM RATINGS ( $T_A = 25^\circ\text{C}$ )

Rating	Symbol	Max	Unit
Reverse Voltage	$V_R$	70	Vdc
Forward Current	$I_F$	200	mAdc
Peak Forward Surge Current	$I_{FM}(\text{surge})$	500	mAdc

### THERMAL CHARACTERISTICS

Characteristic	Symbol	Max	Unit
Total Device Dissipation, FR-4 Board (Note 1) $T_A = 25^\circ\text{C}$ Derated above $25^\circ\text{C}$	$P_D$	225	mW
Thermal Resistance, Junction to Ambient (Note 1)	$R_{\theta JA}$	555	$^\circ\text{C}/\text{W}$
Total Device Dissipation, FR-4 Board (Note 2) $T_A = 25^\circ\text{C}$ Derated above $25^\circ\text{C}$	$P_D$	360	mW
Thermal Resistance, Junction-to-Ambient (Note 2)	$R_{\theta JA}$	345	$^\circ\text{C}/\text{W}$
Junction and Storage Temperature Range	$T_J, T_{stg}$	-55 to +150	$^\circ\text{C}$

Stresses exceeding Maximum Ratings may damage the device. Maximum Ratings are stress ratings only. Functional operation above the Recommended Operating Conditions is not implied. Extended exposure to stresses above the Recommended Operating Conditions may affect device reliability.

1. FR-4 @ Minimum Pad
2. FR-4 @ 1.0 x 1.0 Inch Pad



ON Semiconductor®

<http://onsemi.com>

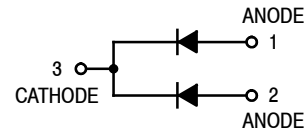

### MARKING DIAGRAM

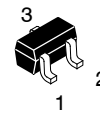

CASE 463  
SOT-416/SC-75  
STYLE 3

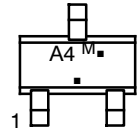

A4 = Specific Device Code  
M = Date Code  
■ = Pb-Free Package

### ORDERING INFORMATION

Device	Package	Shipping†
BAV70TT1G	SOT-416 (Pb-Free)	3000 / Tape & Reel

†For information on tape and reel specifications, including part orientation and tape sizes, please refer to our Tape and Reel Packaging Specifications Brochure, BRD8011/D.

# BAV70TT1G

## ELECTRICAL CHARACTERISTICS ( $T_A = 25^\circ\text{C}$ unless otherwise noted)

Characteristic	Symbol	Min	Max	Unit
<b>OFF CHARACTERISTICS</b>				
Reverse Breakdown Voltage ( $I_{(BR)} = 100 \mu\text{Adc}$ )	$V_{(BR)}$	70	-	Vdc
Reverse Voltage Leakage Current (Note 3) ( $V_R = 70 \text{ Vdc}$ ) ( $V_R = 50 \text{ Vdc}$ )	$I_R$ $I_R$	- -	5.0 100	$\mu\text{Adc}$ nAdc
Diode Capacitance ( $V_R = 0, f = 1.0 \text{ MHz}$ )	$C_D$	-	1.5	pF
Forward Voltage ( $I_F = 1.0 \text{ mAdc}$ ) ( $I_F = 10 \text{ mAdc}$ ) ( $I_F = 50 \text{ mAdc}$ ) ( $I_F = 150 \text{ mAdc}$ )	$V_F$	- - - -	715 855 1000 1250	mVdc
Reverse Recovery Time ( $I_F = I_R = 10 \text{ mAdc}, R_L = 100 \Omega, I_{R(REC)} = 1.0 \text{ mAdc}$ ) (Figure 1)	$t_{rr}$	-	6.0	ns
Forward Recovery Voltage ( $I_F = 10 \text{ mAdc}, t_r = 20 \text{ ns}$ ) (Figure 2)	$V_{RF}$	-	1.75	V

3. For each individual diode while the second diode is unbiased.

# BAV70TT1G

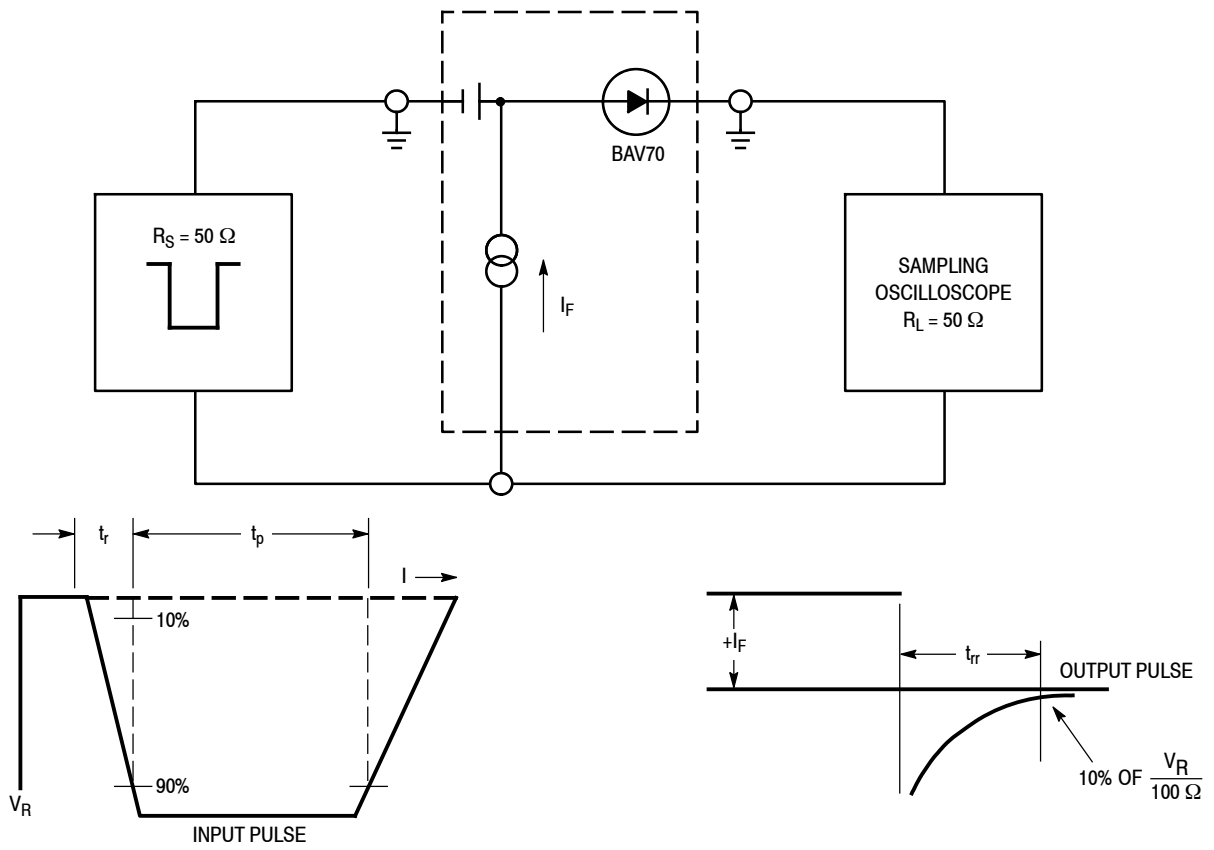

Figure 1. Recovery Time Equivalent Test Circuit

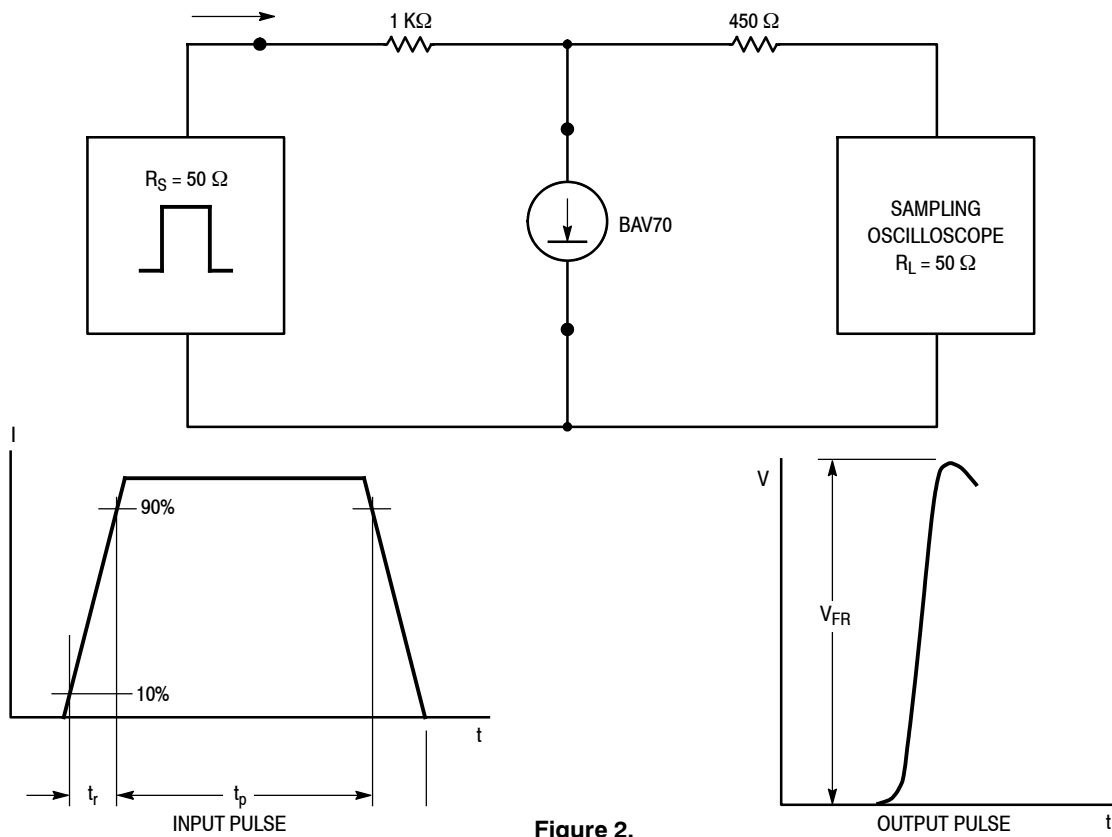

Figure 2.

# BAV70TT1G

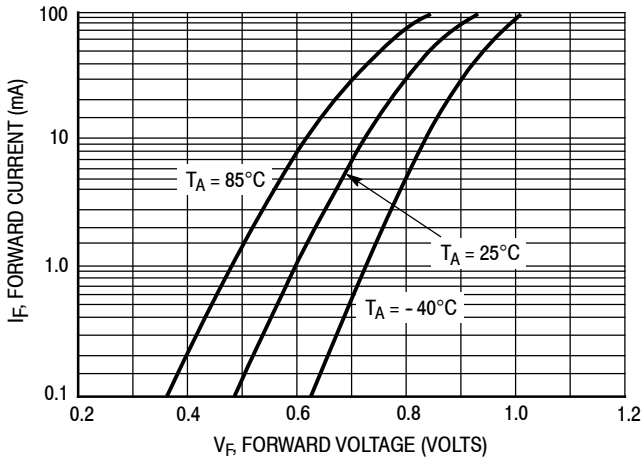

Figure 3. Forward Voltage

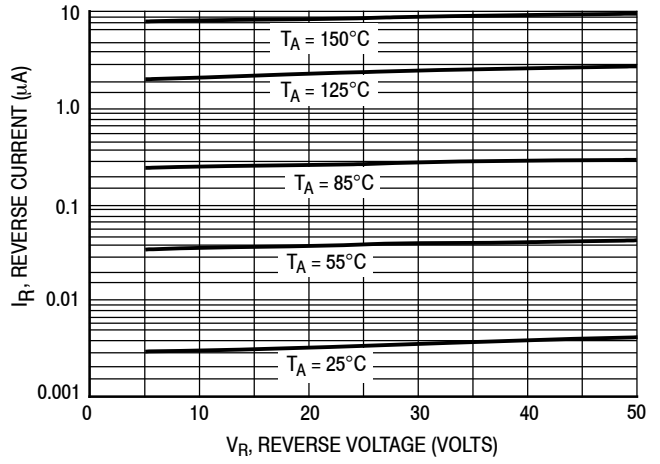

Figure 4. Leakage Current

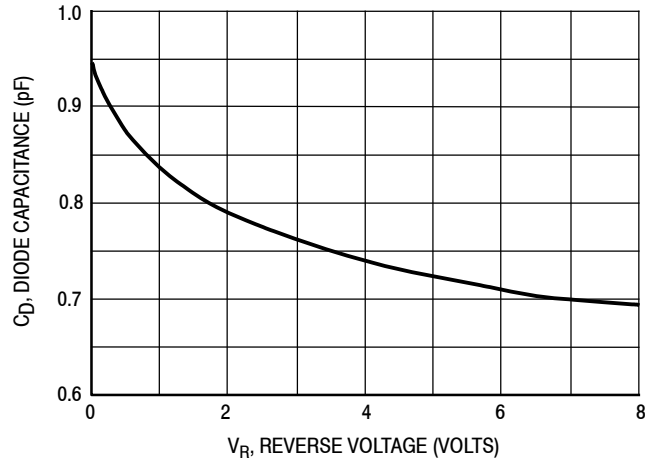

Figure 5. Capacitance

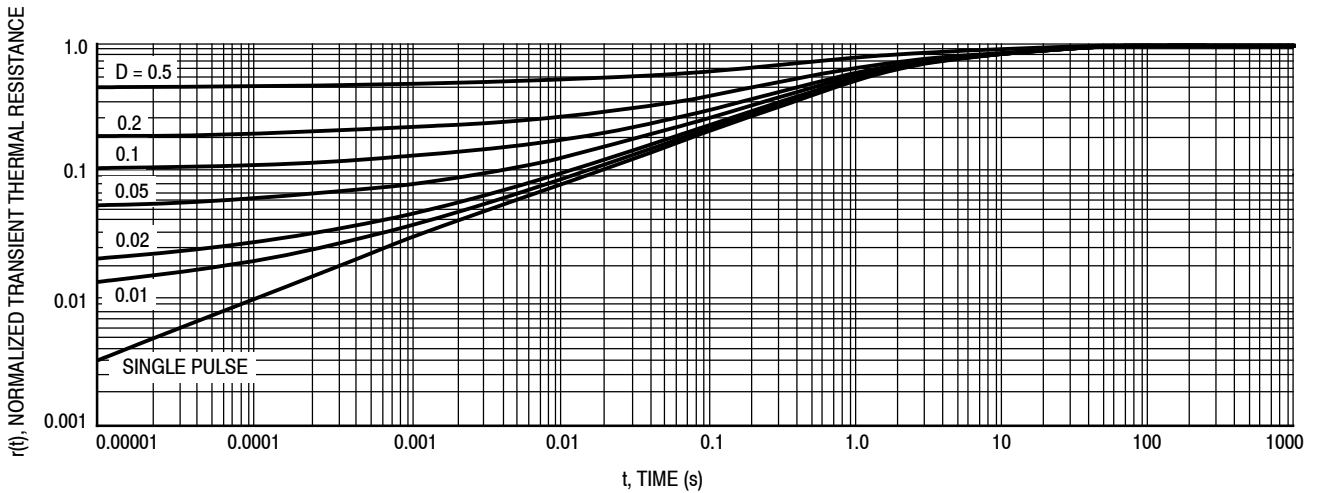
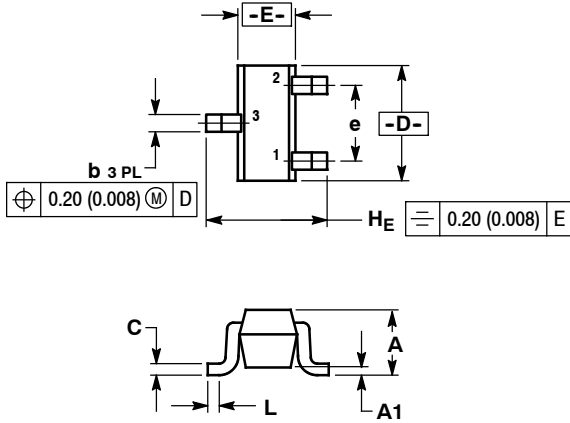

Figure 6. Normalized Thermal Response

# BAV70TT1G

## PACKAGE DIMENSIONS

SC-75/SOT-416  
CASE 463-01  
ISSUE F



NOTES:

1. DIMENSIONING AND TOLERANCING PER ANSI Y14.5M, 1982.
2. CONTROLLING DIMENSION: MILLIMETER.

DIM	MILLIMETERS			INCHES		
	MIN	NOM	MAX	MIN	NOM	MAX
A	0.70	0.80	0.90	0.027	0.031	0.035
A1	0.00	0.05	0.10	0.000	0.002	0.004
b	0.15	0.20	0.30	0.006	0.008	0.012
C	0.10	0.15	0.25	0.004	0.006	0.010
D	1.55	1.60	1.65	0.059	0.063	0.067
E	0.70	0.80	0.90	0.027	0.031	0.035
e	1.00 BSC			0.04 BSC		
L	0.10	0.15	0.20	0.004	0.006	0.008
H <sub>E</sub>	1.50	1.60	1.70	0.061	0.063	0.065

STYLE 3:

1. BASE
2. EMITTER
3. COLLECTOR

### SOLDERING FOOTPRINT\*

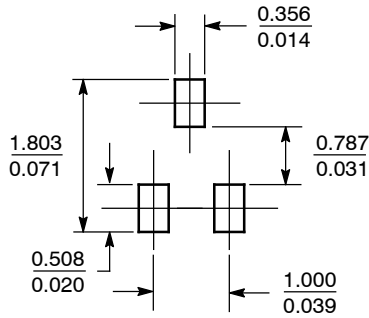

SCALE 10:1  $\left( \frac{\text{mm}}{\text{inches}} \right)$

\*For additional information on our Pb-Free strategy and soldering details, please download the ON Semiconductor Soldering and Mounting Techniques Reference Manual, SOLDERRM/D.

ON Semiconductor and are registered trademarks of Semiconductor Components Industries, LLC (SCILLC). SCILLC reserves the right to make changes without further notice to any products herein. SCILLC makes no warranty, representation or guarantee regarding the suitability of its products for any particular purpose, nor does SCILLC assume any liability arising out of the application or use of any product or circuit, and specifically disclaims any and all liability, including without limitation special, consequential or incidental damages. "Typical" parameters which may be provided in SCILLC data sheets and/or specifications can and do vary in different applications and actual performance may vary over time. All operating parameters, including "Typicals" must be validated for each customer application by customer's technical experts. SCILLC does not convey any license under its patent rights nor the rights of others. SCILLC products are not designed, intended, or authorized for use as components in systems intended for surgical implant into the body, or other applications intended to support or sustain life, or for any other application in which the failure of the SCILLC product could create a situation where personal injury or death may occur. Should Buyer purchase or use SCILLC products for any such unintended or unauthorized application, Buyer shall indemnify and hold SCILLC and its officers, employees, subsidiaries, affiliates, and distributors harmless against all claims, costs, damages, and expenses, and reasonable attorney fees arising out of, directly or indirectly, any claim of personal injury or death associated with such unintended or unauthorized use, even if such claim alleges that SCILLC was negligent regarding the design or manufacture of the part. SCILLC is an Equal Opportunity/Affirmative Action Employer. This literature is subject to all applicable copyright laws and is not for resale in any manner.

### PUBLICATION ORDERING INFORMATION

**LITERATURE FULFILLMENT:**  
Literature Distribution Center for ON Semiconductor  
P.O. Box 5163, Denver, Colorado 80217 USA  
Phone: 303-675-2175 or 800-344-3860 Toll Free USA/Canada  
Fax: 303-675-2176 or 800-344-3867 Toll Free USA/Canada  
Email: orderlit@onsemi.com

**N. American Technical Support:** 800-282-9855 Toll Free  
USA/Canada  
**Europe, Middle East and Africa Technical Support:**  
Phone: 421 33 790 2910  
**Japan Customer Focus Center**  
Phone: 81-3-5773-3850

**ON Semiconductor Website:** [www.onsemi.com](http://www.onsemi.com)

**Order Literature:** <http://www.onsemi.com/orderlit>

For additional information, please contact your local Sales Representative